

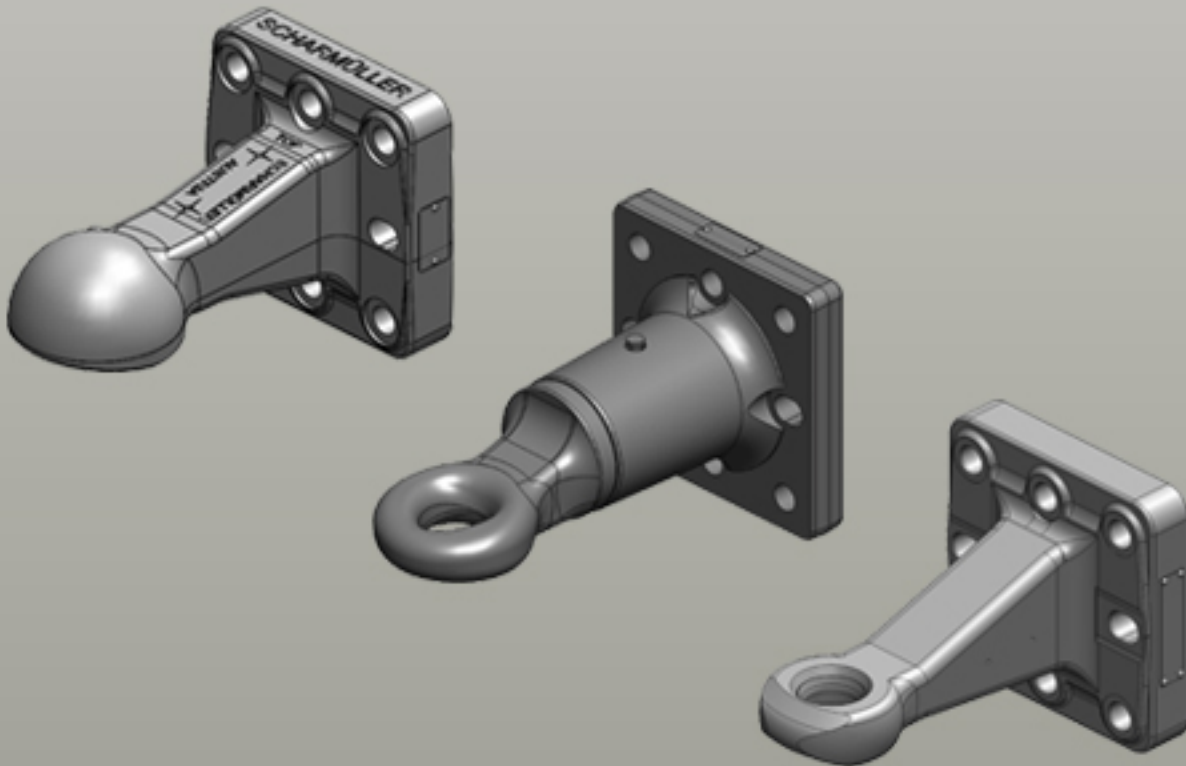









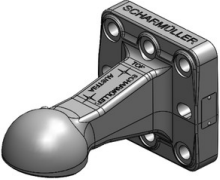

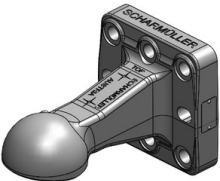
# Towing Eyes | Flange

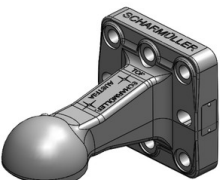

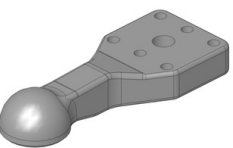

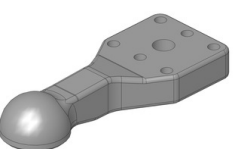
## K80® Towing Eye Ball Coupling System

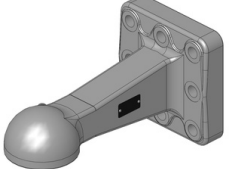

## Towing Eyes | Flange

	<p><b>Art.Nr. 00.650.90.3-A02   Towing Eyes   Flange</b>  K80® Towing Eye Ball Coupling System  </p> <p><b>Alternative color</b> </p> <p>00.650.90.3-A02 (Black )</p> <p><b>Technical Values*</b></p> <p><b>Flange Hole Pattern (mm):</b> 145x145   <b>Thread:</b> M20   <b>Hole Pattern Holes:</b> 8   <b>Flange Alignment:</b> Vertical   <b>Working Length (mm):</b> 252   <b>Max. Permissible Vertical Load (kg):</b> 6000   <b>Max. Permissible Dc-Value (kN):</b> 122,9   <b>Max. Permissible V-Value (kN):</b> 77,8   <b>Approval Status:</b> ECE-147R</p>
	<p><b>Art.Nr. 00.650.901.0-A02   Towing Eyes   Flange</b>  K80® Towing Eye Ball Coupling System  </p> <p><b>Alternative color</b> </p> <p>00.650.901.0-A02 (Black )</p> <p><b>Technical Values*</b></p> <p><b>Flange Hole Pattern (mm):</b> 145x145   <b>Thread:</b> M20   <b>Hole Pattern Holes:</b> 8   <b>Flange Alignment:</b> Vertical   <b>Working Length (mm):</b> 254   <b>Max. Permissible D-Value (kN):</b> 120,2   <b>Max. Permissible Vertical Load (kg):</b> 4000   <b>Approval Status:</b> VO (EU) 2015/208</p>
	<p><b>Art.Nr. 00.650.908.0-A02   Towing Eyes   Flange</b>  K80® Towing Eye Ball Coupling System  </p> <p><b>Alternative color</b> </p> <p>00.650.908.0-A02 (Black )</p> <p><b>Technical Values*</b></p> <p><b>Flange Hole Pattern (mm):</b> 145x145   <b>Thread:</b> M20   <b>Hole Pattern Holes:</b> 8   <b>Flange Alignment:</b> Vertical   <b>Working Length (mm):</b> 252   <b>Max. Permissible Vertical Load (kg):</b> 1000   <b>Max. Permissible Dc-Value (kN):</b> 165   <b>Max. Permissible V-Value (kN):</b> 105   <b>Approval Status:</b> ECE-55R</p>
	<p><b>Art.Nr. 00.650.91.1-A02   Towing Eyes   Flange</b>  K80® Towing Eye Ball Coupling System  </p> <p>Assembly underside of Drawbar</p> <p><b>Alternative color</b> </p> <p>00.650.91.1-A02 (Black )</p> <p><b>Technical Values*</b></p> <p><b>Flange Hole Pattern (mm):</b> 130x115   <b>Thread:</b> M20   <b>Hole Pattern Holes:</b> 6   <b>Flange Alignment:</b> Horizontal   <b>Working Length (mm):</b> 314   <b>Max. Permissible D-Value (kN):</b> 102,4   <b>Max. Permissible Vertical Load (kg):</b> 4000   <b>Approval Status:</b> VO (EU) 2015/208</p> <p><b>Geeignete Anhänger</b></p> <p><b>Annaburger:</b>      <b>Annaburger:</b> Annaburger;</p>
	<p><b>Art.Nr. 00.650.910.0-A02   Towing Eyes   Flange</b>  K80® Towing Eye Ball Coupling System  </p> <p>Assembly upper side of Drawbar</p> <p><b>Alternative color</b> </p> <p>00.650.910.0-A02 (Black )</p> <p><b>Technical Values*</b></p> <p><b>Flange Hole Pattern (mm):</b> 130x115   <b>Thread:</b> M20   <b>Hole Pattern Holes:</b> 6   <b>Flange Alignment:</b> Horizontal   <b>Working Length (mm):</b> 314   <b>Max. Permissible D-Value (kN):</b> 102,4   <b>Max. Permissible Vertical Load (kg):</b> 4000   <b>Approval Status:</b> VO (EU) 2015/208</p>

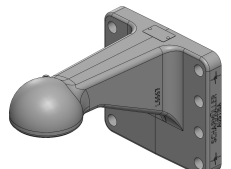







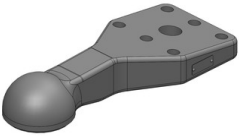

## Towing Eyes | Flange

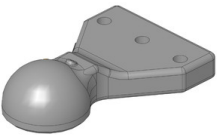
	<p><b>Art.Nr. 00.650.94.0-A02   Towing Eyes   Flange</b>  K80® Towing Eye Ball Coupling System  </p> <p><b>Alternative color</b> </p> <p>00.650.94.0-A02 (Black )   00.650.94.0-A20 (Pöttinger-Red)</p> <p><b>Technical Values*</b></p> <p><b>Flange Hole Pattern (mm):</b> 130x115   <b>Thread:</b> M20   <b>Hole Pattern Holes:</b> 6   <b>Flange Alignment:</b> Horizontal   <b>Working Length (mm):</b> 314   <b>Max. Permissible D-Value (kN):</b> 98,1   <b>Max. Permissible Vertical Load (kg):</b> 2000   <b>Approval Status:</b> VO (EU) 2015/208</p> <p><b>Geeignete Anhänger</b></p> <p><b>Annaburger:</b>      <b>Annaburger:</b> Annaburger;</p>
	<p><b>Art.Nr. 00.650.95.0-A02   Towing Eyes   Flange</b>  K80® Towing Eye Ball Coupling System  </p> <p><b>Alternative color</b> </p> <p>00.650.95.0-A02 (Black )</p> <p><b>Technical Values*</b></p> <p><b>Flange Hole Pattern (mm):</b> 145x145   <b>Thread:</b> M20   <b>Hole Pattern Holes:</b> 8   <b>Flange Alignment:</b> Vertical   <b>Working Length (mm):</b> 320   <b>Max. Permissible D-Value (kN):</b> 120,2   <b>Max. Permissible Vertical Load (kg):</b> 4000   <b>Approval Status:</b> VO (EU) 2015/208</p>
	<p><b>Art.Nr. 00.650.96.0-A02   Towing Eyes   Flange</b>  K80® Towing Eye Ball Coupling System  </p> <p><b>Alternative color</b> </p> <p>00.650.96.0-A02 (Black )</p> <p><b>Technical Values*</b></p> <p><b>Flange Hole Pattern (mm):</b> 180x205   <b>Thread:</b> M20   <b>Hole Pattern Holes:</b> 8   <b>Flange Alignment:</b> Vertical   <b>Working Length (mm):</b> 255   <b>Max. Permissible D-Value (kN):</b> 102,4   <b>Max. Permissible Vertical Load (kg):</b> 4000   <b>Approval Status:</b> 94/20/EC</p> <p><b>Geeignete Anhänger</b></p> <p><b>Samson:</b>      <b>Samson:</b> Samson;</p>
	<p><b>Art.Nr. 00.650.99.0-A02   Towing Eyes   Flange</b>  K80® Towing Eye Ball Coupling System  </p> <p><b>Alternative color</b> </p> <p>00.650.99.0-A02 (Black )</p> <p><b>Technical Values*</b></p> <p><b>Flange Hole Pattern (mm):</b> 180x205   <b>Thread:</b> M20   <b>Hole Pattern Holes:</b> 8   <b>Flange Alignment:</b> Vertical   <b>Working Length (mm):</b> 292   <b>Max. Permissible D-Value (kN):</b> 120,2   <b>Max. Permissible Vertical Load (kg):</b> 4000   <b>Approval Status:</b> VO (EU) 2015/208</p> <p><b>Geeignete Anhänger</b></p> <p><b>Samson:</b>      <b>Samson:</b> Samson;</p>
	<p><b>Art.Nr. 00.652.92.1-A02   Towing Eyes   Flange</b>  K80® Towing Eye Ball Coupling System  </p> <p><b>Alternative color</b> </p> <p>00.652.92.1-A02 (Black )</p> <p><b>Technical Values*</b></p> <p><b>Flange Hole Pattern (mm):</b> 110x100   <b>Thread:</b> M16   <b>Hole Pattern Holes:</b> 8   <b>Flange Alignment:</b> Vertical   <b>Working Length (mm):</b> 243   <b>Max. Permissible D-Value (kN):</b> 89,3   <b>Max. Permissible Vertical Load (kg):</b> 3000   <b>Approval Status:</b> VO (EU) 2015/208</p>

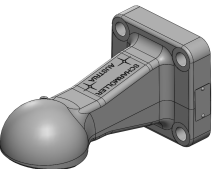
## Towing Eyes | Flange

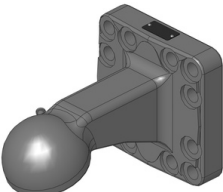
	<p><b>Art.Nr. 00.652.96.1-A02   Towing Eyes   Flange</b>  K80® Towing Eye Ball Coupling System  </p> <p><b>Alternative color</b> </p> <p>00.652.96.1-A02 (Black )</p> <p><b>Technical Values*</b></p> <p><b>Flange Hole Pattern (mm):</b> 110x100   <b>Thread:</b> M16   <b>Hole Pattern Holes:</b> 8   <b>Flange Alignment:</b> Vertical   <b>Working Length (mm):</b> 248   <b>Max. Permissible D-Value (kN):</b> 87,2   <b>Max. Permissible Vertical Load (kg):</b> 2000   <b>Approval Status:</b> ABG General Type Approval</p>
	<p><b>Art.Nr. 00.652.960.0-A02   Towing Eyes   Flange</b>  K80® Towing Eye Ball Coupling System  </p> <p><b>Alternative color</b> </p> <p>00.652.960.0-A02 (Black )</p> <p><b>Technical Values*</b></p> <p><b>Flange Hole Pattern (mm):</b> 110x100   <b>Thread:</b> M20x1,5   <b>Hole Pattern Holes:</b> 8   <b>Flange Alignment:</b> Vertical   <b>Working Length (mm):</b> 290   <b>Max. Permissible D-Value (kN):</b> 89,3   <b>Max. Permissible Vertical Load (kg):</b> 2500   <b>Approval Status:</b> VO (EU) 2015/208</p>
	<p><b>Art.Nr. 00.652.99.0-A02   Towing Eyes   Flange</b>  K80® Towing Eye Ball Coupling System  </p> <p><b>Alternative color</b> </p> <p>00.652.99.0-A02 (Black )</p> <p><b>Technical Values*</b></p> <p><b>Flange Hole Pattern (mm):</b> 110x100   <b>Thread:</b> M16   <b>Hole Pattern Holes:</b> 8   <b>Flange Alignment:</b> Vertical   <b>Working Length (mm):</b> 173   <b>Max. Permissible D-Value (kN):</b> 89,3   <b>Max. Permissible Vertical Load (kg):</b> 4000   <b>Approval Status:</b> VO (EU) 2015/208</p>
	<p><b>Art.Nr. 00.653.901.0-A02   Towing Eyes   Flange</b>  K80® Towing Eye Ball Coupling System  </p> <p><b>Alternative color</b> </p> <p>00.653.901.0-A02 (Black )</p> <p><b>Technical Values*</b></p> <p><b>Flange Hole Pattern (mm):</b> 130x130   <b>Thread:</b> M20   <b>Hole Pattern Holes:</b> 8   <b>Flange Alignment:</b> Vertical   <b>Working Length (mm):</b> 240   <b>Max. Permissible D-Value (kN):</b> 120,2   <b>Max. Permissible Vertical Load (kg):</b> 4000   <b>Approval Status:</b> VO (EU) 2015/208</p>
	<p><b>Art.Nr. 00.654.89.0-A02   Towing Eyes   Flange</b>  K80® Towing Eye Ball Coupling System  </p> <p><b>Alternative color</b> </p> <p>00.654.89.0-A02 (Black )</p> <p><b>Technical Values*</b></p> <p><b>Flange Hole Pattern (mm):</b> 145x145   <b>Thread:</b> M20   <b>Hole Pattern Holes:</b> 8   <b>Flange Alignment:</b> Vertical   <b>Working Length (mm):</b> 240   <b>Inclination:</b> 20°   <b>Max. Permissible D-Value (kN):</b> 91,6   <b>Max. Permissible Vertical Load (kg):</b> 3000   <b>Approval Status:</b> 94/20/EC</p>

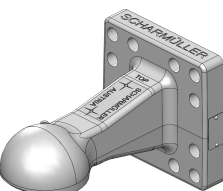
## Towing Eyes | Flange

	<p><b>Art.Nr. 00.655.90.0-A02   Towing Eyes   Flange</b>  K80® Towing Eye Ball Coupling System  </p> <p><b>Alternative color</b> </p> <p>00.655.90.0-A02 (Black )</p> <p><b>Technical Values*</b></p> <p><b>Flange Hole Pattern (mm):</b> 130x115   <b>Hole Pattern Holes:</b> 6   <b>Flange Alignment:</b> Horizontal   <b>Working Length (mm):</b> 314   <b>Max. Permissible D-Value (kN):</b> 102,4   <b>Max. Permissible Vertical Load (kg):</b> 4000   <b>Approval Status:</b> VO (EU) 2015/208</p> <p><b>Geeignete Anhänger</b></p> <p><b>Annaburger:</b>      <b>Annaburger:</b> Annaburger;</p>
	<p><b>Art.Nr. 00.663.82.0-A02   Towing Eyes   Flange</b>  K80® Towing Eye Ball Coupling System  </p> <p><b>Alternative color</b> </p> <p>00.663.82.0-A02 (Black )</p> <p><b>Technical Values*</b></p> <p><b>Thread:</b> M20   <b>Hole Pattern Holes:</b> 3   <b>Flange Alignment:</b> Horizontal   <b>Working Length (mm):</b> 190   <b>Max. Permissible D-Value (kN):</b> 57,2   <b>Max. Permissible Vertical Load (kg):</b> 2000   <b>Approval Status:</b> ABG General Type Approval</p> <p><b>Geeignete Anhänger</b></p> <p><b>Horsch:</b>              <b>FG:</b> 11.70, 12, 18, 4.50, 5.70, 7.50; <b>SW:</b> 3500S, 3600S, 5000S, 7000S, 7000SD;</p>
	<p><b>Art.Nr. 00.664.91.1-A02   Towing Eyes   Flange</b>  K80® Towing Eye Ball Coupling System  </p> <p><b>Alternative color</b> </p> <p>00.664.91.1-A02 (Black )</p> <p><b>Technical Values*</b></p> <p><b>Flange Hole Pattern (mm):</b> 120x120   <b>Thread:</b> M20   <b>Hole Pattern Holes:</b> 4   <b>Flange Alignment:</b> Vertical   <b>Working Length (mm):</b> 250   <b>Max. Permissible D-Value (kN):</b> 89,3   <b>Max. Permissible Vertical Load (kg):</b> 3000   <b>Approval Status:</b> VO (EU) 2015/208</p> <p><b>Geeignete Anhänger</b></p> <p><b>Claas:</b>                  <b>Quadrant:</b> 3200, 3400;</p>
	<p><b>Art.Nr. 00.665.89.0-A02   Towing Eyes   Flange</b>  K80® Towing Eye Ball Coupling System  </p> <p><b>Alternative color</b> </p> <p>00.665.89.0-A02 (Black )</p> <p><b>Technical Values*</b></p> <p><b>Flange Hole Pattern (mm):</b> 160x160   <b>Thread:</b> M20   <b>Hole Pattern Holes:</b> 12   <b>Flange Alignment:</b> Vertical   <b>Working Length (mm):</b> 240   <b>Inclination:</b> 20°   <b>Max. Permissible D-Value (kN):</b> 91,6   <b>Max. Permissible Vertical Load (kg):</b> 3000   <b>Approval Status:</b> 94/20/EC</p>
	<p><b>Art.Nr. 00.665.90.3-A02   Towing Eyes   Flange</b>  K80® Towing Eye Ball Coupling System  </p> <p><b>Alternative color</b> </p> <p>00.665.90.3-A02 (Black )</p> <p><b>Technical Values*</b></p> <p><b>Flange Hole Pattern (mm):</b> 160x160   <b>Thread:</b> M20   <b>Hole Pattern Holes:</b> 12   <b>Flange Alignment:</b> Vertical   <b>Working Length (mm):</b> 250   <b>Max. Permissible Vertical Load (kg):</b> 6000   <b>Max. Permissible Dc-Value (kN):</b> 122,9   <b>Max. Permissible V-Value (kN):</b> 77,8   <b>Approval Status:</b> ECE-147R</p>

## Towing Eyes | Flange

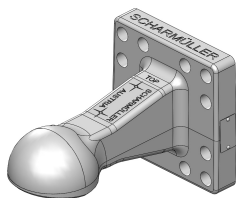

**Art.Nr. 00.665.901.0-A02 | Towing Eyes | Flange**

K80® Towing Eye Ball Coupling System |

**Alternative color**

00.665.901.0-A02 (Black)

**Technical Values\***

**Flange Hole Pattern (mm):** 160x160 | **Thread:** M20 | **Hole Pattern Holes:** 12 | **Flange Alignment:** Vertical |  
**Working Length (mm):** 250 | **Max. Permissible D-Value (kN):** 120 | **Max. Permissible Vertical Load (kg):** 4000 |  
**Approval Status:** VO (EU) 2015/208