

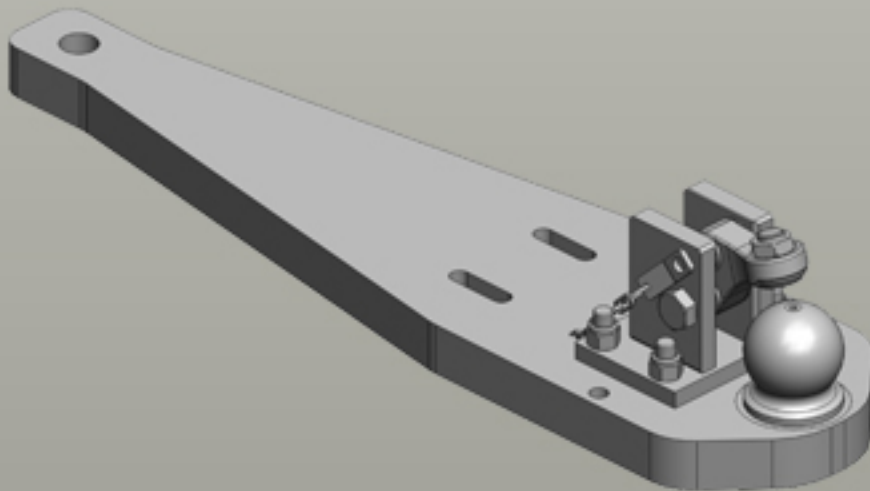

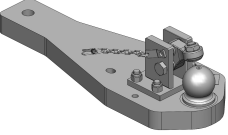







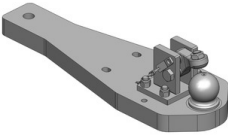

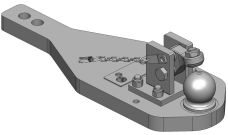

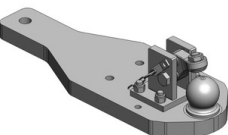

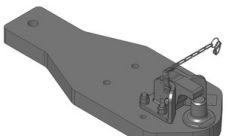
Heavy Duty Drawbars Claas | Arion 600 (A19/A20)

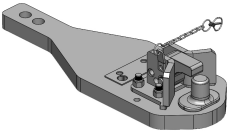

Heavy Duty Drawbars

	<p>Art.Nr. 00.960.639.0-A11 Heavy Duty Drawbars Standard K80® Ball Coupling System </p> <ul style="list-style-type: none"> Fits up from Chassis-Number: V285019 at MF 6445-6480 / A1906772 at Claas Arion 500/600 fits to Original Ladder Hitch (ex factory) with Drawbar Frame <p>Alternative color </p> <p>00.960.639.0-A11 (AGCO-Grey)</p> <p>Technical Values*</p> <p>Lenght (mm): 700 Wide (mm): 245 Assembly-Positions: 1 Thickness (mm): 50 Locking: K80® Manual Max. Permissible D-Value (kN): 78,5 Max. Permissible Vertical Load (kg): 3000</p> <p>Adapted for Tractor</p> <p>Claas: Arion 500 (A18): 510, 520, 530, 540; Arion 600 (A19/A20): 610, 620, 630, 640; Massey Ferguson: 6400 Dyna-4/6 / Dynashift: 6445, 6455, 6460, 6465, 6470, 6475, 6480; 6600 Dyna-6: 6613, 6614, 6615, 6616; 6700 S Dyna-6: 6713, 6714, 6715, 6716, 6718; 7600 Dyna-6: 7615, 7616, 7618; 7700 Dyna-6: 7715, 7716, 7718;</p>
	<p>Art.Nr. 00.960.639.1-A11 Heavy Duty Drawbars Standard K80® Ball Coupling System </p> <ul style="list-style-type: none"> Fits up from Chassis-Number: V285019 at MF 6445-6480 / A1906772 at Claas Arion 500/600 fits to Original Pitonfix Ladder Hitch (ex factory) with Drawbar Frame <p>Alternative color </p> <p>00.960.639.1-A11 (AGCO-Grey)</p> <p>Technical Values*</p> <p>Lenght (mm): 738 Wide (mm): 245 Assembly-Positions: 1 Thickness (mm): 50 Locking: K80® Manual Max. Permissible D-Value (kN): 78,5 Max. Permissible Vertical Load (kg): 3000</p> <p>Adapted for Tractor</p> <p>Claas: Arion 500 (A18): 510, 520, 530, 540; Arion 600 (A19/A20): 610; Massey Ferguson: 6400 Dyna-4/6 / Dynashift: 6445, 6455, 6460, 6465, 6470, 6475, 6480; 6600 Dyna-6: 6613, 6614, 6615, 6616; 6700 S Dyna-6: 6713, 6714, 6715, 6716, 6718; 7600 Dyna-6: 7615, 7616, 7618; 7700 Dyna-6: 7715, 7716, 7718;</p>
	<p>Art.Nr. 00.960.640.0-A11 Heavy Duty Drawbars Standard K80® Ball Coupling System </p> <ul style="list-style-type: none"> Fits up to Chassis-Number: B150019 at MF 5425-5480 / V285018 at MF 6445-6480 / A1906771 at Claas Arion 500/600 fits to Original Ladder Hitch (ex factory) with Drawbar Frame <p>Alternative color </p> <p>00.960.640.0-A11 (AGCO-Grey)</p> <p>Technical Values*</p> <p>Lenght (mm): 703 Wide (mm): 245 Assembly-Positions: 1 Thickness (mm): 40 Locking: K80® Manual Max. Permissible D-Value (kN): 78,5 Max. Permissible Vertical Load (kg): 3000</p> <p>Adapted for Tractor</p> <p>Challenger: MT 500 B AutoPower IV: 525, 535, 545; Claas: Ares 500/600: 546, 547, 556, 557, 566, 567, 577, 616, 617, 656, 657, 696, 697; Ares 800: 816, 826, 836; Arion 500 (A18): 510, 520, 530, 540; Arion 500 (A34/A35): 530, 540, 550; Arion 600 (A19/A20): 610, 620, 630, 640; Arion 600 (A36/A37): 620, 630, 640, 650; Massey Ferguson: 5400: 5425, 5435, 5445, 5455, 5460, 5465, 5470, 5475, 5480; 6200: 6235, 6245, 6255, 6260, 6265, 6270, 6280, 6290; 6400 Dyna-4 (Tier 2): 6485, 6490, 6495; 6400 Dyna-4/6 / Dynashift: 6445, 6455, 6460, 6465, 6470, 6475, 6480;</p>
	<p>Art.Nr. 00.960.647.0-A11 Heavy Duty Drawbars Standard K80® Ball Coupling System </p> <ul style="list-style-type: none"> fits up from Chassis-Number: B150020 at MF 5425-5480 fits to Scharmüller Ladder-Hitch with Drawbar Frame <p>Alternative color </p> <p>00.960.647.0-A11 (AGCO-Grey)</p> <p>Technical Values*</p> <p>Lenght (mm): 646 Wide (mm): 250 Assembly-Positions: 1 Thickness (mm): 40 Locking: K80® Manual Max. Permissible D-Value (kN): 67,6 Max. Permissible Vertical Load (kg): 3000</p> <p>Adapted for Tractor</p> <p>Claas: Arion 400 (A21): 410, 420, 430, 440, 450, 460; Arion 500 (A18): 510, 520, 530, 540; Arion 600 (A19/A20): 610, 620, 630, 640; Massey Ferguson: 5400: 5425, 5435, 5445, 5455, 5460, 5465, 5470, 5475, 5480; 6600 Dyna-4: 6612, 6613, 6615; 7600 Dyna-4: 7614, 7615; 7700 Dyna-4: 7714, 7715;</p>
	<p>Art.Nr. 00.961.639.0-A11 Heavy Duty Drawbars Standard Draw-Pin (Pitonfix) </p> <ul style="list-style-type: none"> Fits up from Chassis-Number: V285019 at MF 6445-6480 / A1906772 at Claas Arion 500/600 fits to Original Ladder Hitch (ex factory) with Drawbar Frame <p>Alternative color </p> <p>00.961.639.0-A11 (AGCO-Grey)</p> <p>Technical Values*</p> <p>Lenght (mm): 700 Wide (mm): 290 Assembly-Positions: 1 Thickness (mm): 50 Locking: Draw Pin (Pitonfix) Manual Max. Permissible D-Value (kN): 78,5 Max. Permissible Vertical Load (kg): 3000</p> <p>Adapted for Tractor</p> <p>Claas: Arion 500 (A18): 510, 520, 530, 540; Arion 600 (A19/A20): 610, 620, 630, 640; Massey Ferguson: 6400 Dyna-4/6 / Dynashift: 6445, 6455, 6460, 6465, 6470, 6475, 6480; 6600 Dyna-6: 6613, 6614, 6615, 6616; 6700 S Dyna-6: 6713, 6714, 6715, 6716, 6718; 7600 Dyna-6: 7615, 7616, 7618; 7700 Dyna-6: 7715, 7716, 7718;</p>

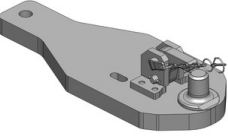
Heavy Duty Drawbars

	Art.Nr. 00.961.640.0-A11 Heavy Duty Drawbars Standard Draw-Pin (Pitonfix)
	<ul style="list-style-type: none"> Fits up to Chassis-Number: B150019 at MF 5425-5480 / V285018 at MF 6445-6480 / A1906771 at Claas Arion 500/600 fits to Original Ladder Hitch (ex factory) with Drawbar Frame
	Alternative color  00.961.640.0-A11 (AGCO-Grey)
	Technical Values* Length (mm): 703 Wide (mm): 245 Assembly-Positions: 2 Thickness (mm): 40 Locking: Draw Pin (Pitonfix) Manual Max. Permissible D-Value (kN): 78,5 Max. Permissible Vertical Load (kg): 3000
	Adapted for Tractor Challenger: MT 500 B AutoPower IV: 525, 535, 545; Claas: Ares 500/600: 546, 547, 556, 557, 566, 567, 577, 616, 617, 656, 657, 696, 697; Ares 800: 816, 826, 836; Arion 500 (A18): 510, 520, 530, 540; Arion 500 (A34/A35): 530, 540, 550; Arion 600 (A19/A20): 610, 620, 630, 640; Arion 600 (A36/A37): 620, 630, 640, 650; Massey Ferguson: 5400: 5425, 5435, 5445, 5455, 5460, 5465, 5470, 5475, 5480; 6200: 6235, 6245, 6255, 6260, 6265, 6270, 6280, 6290; 6400 Dyna-4 (Tier 2): 6485, 6490, 6495;
	Art.Nr. 00.961.645.0-A11 Heavy Duty Drawbars Standard Draw-Pin (Pitonfix)
	<ul style="list-style-type: none"> fits up from Chassis-Number: B150020 at MF 5425-5480 fits to Scharmüller Ladder-Hitch with Drawbar Frame
	Alternative color  00.961.645.0-A11 (AGCO-Grey) 00.961.645.0-A29 (Claas-Grey)
	Technical Values* Length (mm): 613 Wide (mm): 250 Assembly-Positions: 1 Thickness (mm): 40 Locking: Draw Pin (Pitonfix) Manual Max. Permissible D-Value (kN): 67,6 Max. Permissible Vertical Load (kg): 3000
	Adapted for Tractor Claas: Arion 400 (A21): 410, 420, 430, 440, 450, 460; Arion 500 (A18): 510, 520, 530, 540; Arion 600 (A19/A20): 610, 620, 630, 640; Massey Ferguson: 5400: 5425, 5435, 5445, 5455, 5460, 5465, 5470, 5475, 5480; 6600 Dyna-4: 6612, 6613, 6615; 7600 Dyna-4: 7614, 7615; 7700 Dyna-4: 7714, 7715;