

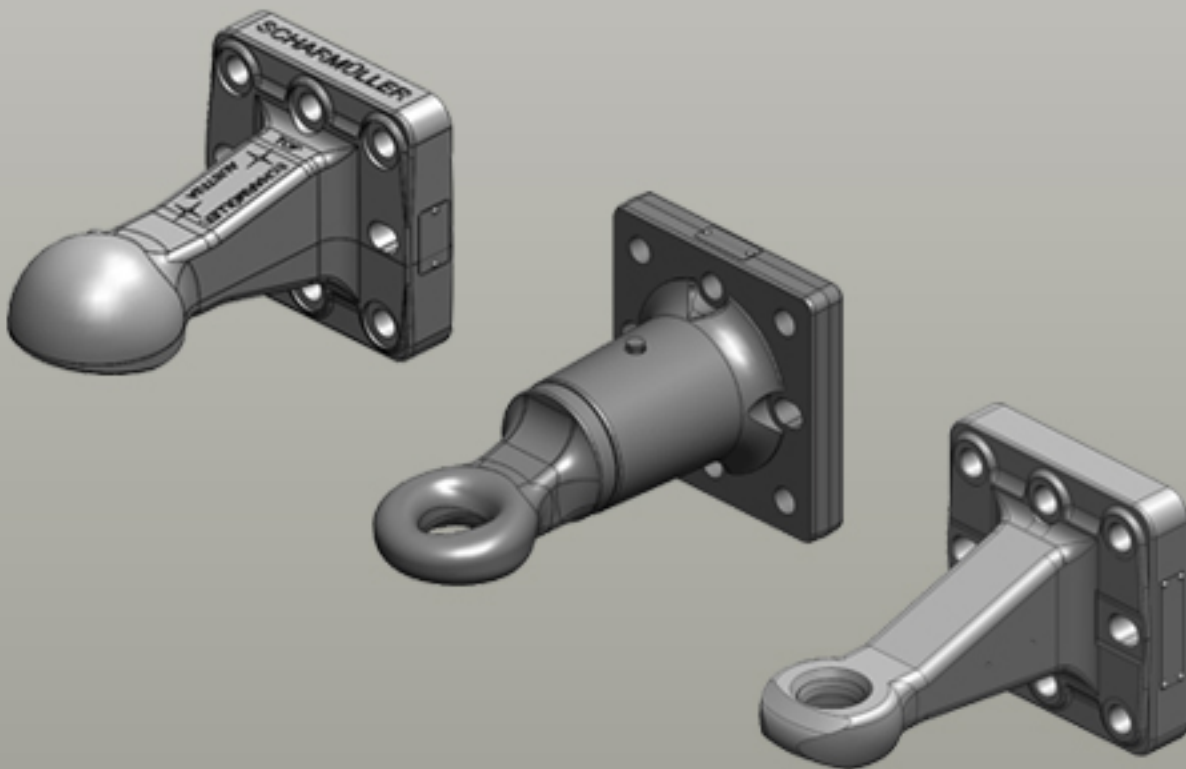









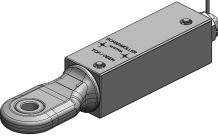

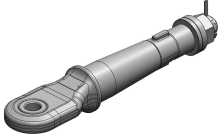
# Towing Eyes | Roundshaft

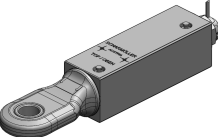

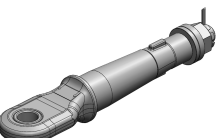

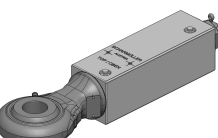



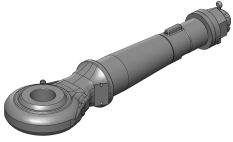

---

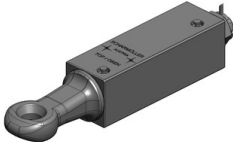

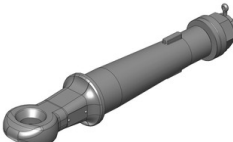
## Towing Eyes | Roundshaft

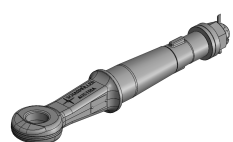
	<p><b>Art.Nr. 00.663.15.0-A02   Towing Eyes   Roundshaft</b>  Ball Joint Towing Eye Cat. 2 DØ33mm  </p> <p><b>Alternative color</b> </p> <p>00.663.15.0-A02 (Black )</p> <p><b>Technical Values*</b></p> <p><b>Shaft Diameter Ø (mm): 80   Thread: M45   Working Length (mm): 148   Bearing Housing (mm): 315   Max. Permissible D-Value (kN): 102,4   Max. Permissible Vertical Load (kg): 3000   Shaft Height x Width: 102x102   Approval Status:</b></p>
	<p><b>Art.Nr. 00.663.150.0-A02   Towing Eyes   Roundshaft</b>  Ball Joint Towing Eye Cat. 2 DØ33mm  </p> <p><b>Alternative color</b> </p> <p>00.663.150.0-A02 (Black )</p> <p><b>Technical Values*</b></p> <p><b>Shaft Diameter Ø (mm): 80   Thread: M45   Working Length (mm): 148   Bearing Housing (mm): 315   Max. Permissible D-Value (kN): 102,4   Max. Permissible Vertical Load (kg): 3000   Approval Status:</b></p>
	<p><b>Art.Nr. 00.663.16.0-A02   Towing Eyes   Roundshaft</b>  Ball Joint Towing Eye Cat. 3 DØ42mm  </p> <p><b>Alternative color</b> </p> <p>00.663.16.0-A02 (Black )</p> <p><b>Technical Values*</b></p> <p><b>Shaft Diameter Ø (mm): 80   Thread: M45   Working Length (mm): 148   Bearing Housing (mm): 315   Max. Permissible D-Value (kN): 102,4   Max. Permissible Vertical Load (kg): 3000   Shaft Height x Width: 102x102   Approval Status: VO (EU) 2015/208</b></p>
	<p><b>Art.Nr. 00.663.160.0-A02   Towing Eyes   Roundshaft</b>  Ball Joint Towing Eye Cat. 3 DØ42mm  </p> <p><b>Alternative color</b> </p> <p>00.663.160.0-A02 (Black )</p> <p><b>Technical Values*</b></p> <p><b>Shaft Diameter Ø (mm): 80   Thread: M45   Working Length (mm): 148   Bearing Housing (mm): 315   Max. Permissible D-Value (kN): 102,4   Max. Permissible Vertical Load (kg): 3000   Approval Status: VO (EU) 2015/208</b></p>
	<p><b>Art.Nr. 00.663.17.0-A02   Towing Eyes   Roundshaft</b>  Ball Joint Towing Eye Cat. 4 DØ51mm  </p> <p><b>Alternative color</b> </p> <p>00.663.17.0-A02 (Black )</p> <p><b>Technical Values*</b></p> <p><b>Shaft Diameter Ø (mm): 80   Thread: M45   Working Length (mm): 154   Bearing Housing (mm): 315   Max. Permissible D-Value (kN): 102,4   Max. Permissible Vertical Load (kg): 3000   Shaft Height x Width: 102x102   Approval Status: VO (EU) 2015/208</b></p>

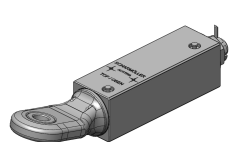

## Towing Eyes | Roundshaft

	<p><b>Art.Nr. 00.663.170.0-A02   Towing Eyes   Roundshaft</b>  Ball Joint Towing Eye Cat. 4 DØ51mm  </p> <p><b>Alternative color</b> </p> <p>00.663.170.0-A02 (Black )</p> <p><b>Technical Values*</b></p> <p><b>Shaft Diameter Ø (mm): 80   Thread: M45   Working Length (mm): 154   Bearing Housing (mm): 315   Max. Permissible D-Value (kN): 102,4   Max. Permissible Vertical Load (kg): 3000   Approval Status: VO (EU) 2015/208</b></p>
	<p><b>Art.Nr. 00.663.251.0-A02   Towing Eyes   Roundshaft</b>  Standard Towing Eye DØ40mm (42mm thick)  </p> <p><b>Alternative color</b> </p> <p>00.663.251.0-A02 (Black )</p> <p><b>Technical Values*</b></p> <p><b>Shaft Diameter Ø (mm): 80   Thread: M45   Working Length (mm): 139   Bearing Housing (mm): 315   Max. Permissible D-Value (kN): 102,4   Max. Permissible Vertical Load (kg): 2500   Shaft Height x Width: 102x102   Approval Status: ABG General Type Approval</b></p>
	<p><b>Art.Nr. 00.663.252.0-A02   Towing Eyes   Roundshaft</b>  Standard Towing Eye DØ40mm (42mm thick)  </p> <p><b>Alternative color</b> </p> <p>00.663.252.0-A02 (Black )</p> <p><b>Technical Values*</b></p> <p><b>Shaft Diameter Ø (mm): 80   Thread: M45   Working Length (mm): 139   Bearing Housing (mm): 315   Max. Permissible D-Value (kN): 102,4   Max. Permissible Vertical Load (kg): 2500   Approval Status: ABG General Type Approval</b></p>
	<p><b>Art.Nr. 00.663.300.0-A02   Towing Eyes   Roundshaft</b>  Standard Towing Eye DØ50mm (truck/lorry towing eye)  </p> <p><b>Alternative color</b> </p> <p>00.663.300.0-A02 (Black )</p> <p><b>Technical Values*</b></p> <p><b>Shaft Diameter Ø (mm): 80   Thread: M45   Working Length (mm): 197   Bearing Housing (mm): 315   Max. Permissible D-Value (kN): 190   Max. Permissible Vertical Load (kg): 1000   Max. Permissible Dc-Value (kN): 120   Max. Permissible V-Value (kN): 50   Approval Status:</b></p>
	<p><b>Art.Nr. 00.663.35.0-A02   Towing Eyes   Roundshaft</b>  Ball Joint Towing Eye Cat. 2 DØ33mm  </p> <p><b>Alternative color</b> </p> <p>00.663.35.0-A02 (Black )</p> <p><b>Technical Values*</b></p> <p><b>Shaft Diameter Ø (mm): 80   Thread: M45   Working Length (mm): 145   Inclination: 15°   Bearing Housing (mm): 315   Max. Permissible D-Value (kN): 102,4   Max. Permissible Vertical Load (kg): 3000   Shaft Height x Width: 102x102   Approval Status:</b></p>







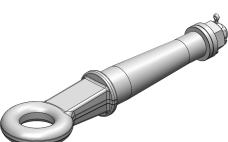

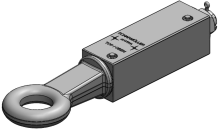

## Towing Eyes | Roundshaft

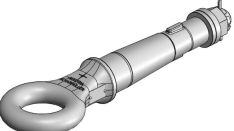
	<p><b>Art.Nr. 00.663.350.0-A02   Towing Eyes   Roundshaft</b>  Ball Joint Towing Eye Cat. 2 DØ33mm  </p> <p><b>Alternative color</b> </p> <p>00.663.350.0-A02 (Black )</p> <p><b>Technical Values*</b></p> <p><b>Shaft Diameter Ø (mm): 80   Thread: M45   Working Length (mm): 145   Inclination: 15°   Bearing Housing (mm): 315   Max. Permissible D-Value (kN): 102,4   Max. Permissible Vertical Load (kg): 3000   Approval Status:</b></p>
	<p><b>Art.Nr. 00.663.36.0-A02   Towing Eyes   Roundshaft</b>  Ball Joint Towing Eye Cat. 3 DØ42mm  </p> <p><b>Alternative color</b> </p> <p>00.663.36.0-A02 (Black )</p> <p><b>Technical Values*</b></p> <p><b>Shaft Diameter Ø (mm): 80   Thread: M45   Working Length (mm): 145   Inclination: 15°   Bearing Housing (mm): 315   Max. Permissible D-Value (kN): 102,4   Max. Permissible Vertical Load (kg): 3000   Shaft Height x Width: 102x102   Approval Status:</b></p>
	<p><b>Art.Nr. 00.663.360.0-A02   Towing Eyes   Roundshaft</b>  Ball Joint Towing Eye Cat. 3 DØ42mm  </p> <p><b>Alternative color</b> </p> <p>00.663.360.0-A02 (Black )</p> <p><b>Technical Values*</b></p> <p><b>Shaft Diameter Ø (mm): 80   Thread: M45   Working Length (mm): 145   Inclination: 15°   Bearing Housing (mm): 315   Max. Permissible D-Value (kN): 102,4   Max. Permissible Vertical Load (kg): 3000   Approval Status:</b></p>
	<p><b>Art.Nr. 00.663.450.0-A02   Towing Eyes   Roundshaft</b>  Ring Towing Eye DØ50mm turnable (Pickup Hitchring)  </p> <p><b>Alternative color</b> </p> <p>00.663.450.0-A02 (Black )   00.663.450.0-A20 (Pöttinger-Red)</p> <p><b>Technical Values*</b></p> <p><b>Shaft Diameter Ø (mm): 80   Thread: M45   Working Length (mm): 139   Bearing Housing (mm): 315   Max. Permissible D-Value (kN): 102,4   Max. Permissible Vertical Load (kg): 4000   Approval Status:</b>  ABG General Type Approval</p>
	<p><b>Art.Nr. 00.663.451.0-A02   Towing Eyes   Roundshaft</b>  Ring Towing Eye DØ50mm turnable (Pickup Hitchring)  </p> <p><b>Alternative color</b> </p> <p>00.663.451.0-A02 (Black )</p> <p><b>Technical Values*</b></p> <p><b>Shaft Diameter Ø (mm): 80   Thread: M45   Working Length (mm): 139   Bearing Housing (mm): 315   Max. Permissible D-Value (kN): 102,4   Max. Permissible Vertical Load (kg): 4000   Shaft Height x Width: 102x102   Approval Status:</b>  ABG General Type Approval</p>

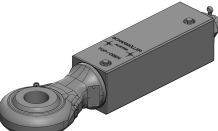

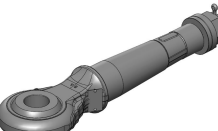

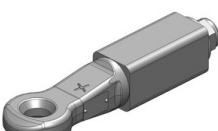

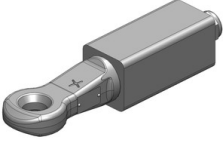

## Towing Eyes | Roundshaft

	<p><b>Art.Nr. 00.663.452.0-A02   Towing Eyes   Roundshaft</b>  Ring Towing Eye DØ50mm turnable (Pickup Hitchring)  </p> <p><b>Alternative color</b> </p> <p>00.663.452.0-A02 (Black )</p> <p><b>Technical Values*</b></p> <p><b>Shaft Diameter Ø (mm): 80   Thread: M45   Working Length (mm): 207   Bearing Housing (mm): 315   Max. Permissible D-Value (kN): 120,2   Max. Permissible Vertical Load (kg): 3000   Approval Status: VO (EU) 2015/208</b></p>
	<p><b>Art.Nr. 00.663.453.0-A02   Towing Eyes   Roundshaft</b>  Ring Towing Eye DØ50mm turnable (Pickup Hitchring)  </p> <p><b>Alternative color</b> </p> <p>00.663.453.0-A02 (Black )</p> <p><b>Technical Values*</b></p> <p><b>Shaft Diameter Ø (mm): 80   Thread: M45   Working Length (mm): 207   Bearing Housing (mm): 315   Max. Permissible D-Value (kN): 120,2   Max. Permissible Vertical Load (kg): 3000   Shaft Height x Width: 102x102   Approval Status: VO (EU) 2015/208</b></p>
	<p><b>Art.Nr. 00.663.62.0-A02   Towing Eyes   Roundshaft</b>  Ring Towing Eye Cuna F2 DØ50mm turnable  </p> <p>Only useable in Italy</p> <p><b>Alternative color</b> </p> <p>00.663.62.0-A02 (Black )</p> <p><b>Technical Values*</b></p> <p><b>Shaft Diameter Ø (mm): 80   Thread: M45   Working Length (mm): 194   Bearing Housing (mm): 315   Max. Permissible Vertical Load (kg): 2000   Max. Permissible Towable Mass (kg): 14000   Approval Status: CUNA</b></p>
	<p><b>Art.Nr. 00.663.620.0-A02   Towing Eyes   Roundshaft</b>  Ring Towing Eye Cuna F2 DØ50mm turnable  </p> <p>Only useable in Italy</p> <p><b>Alternative color</b> </p> <p>00.663.620.0-A02 (Black )</p> <p><b>Technical Values*</b></p> <p><b>Shaft Diameter Ø (mm): 80   Thread: M45   Working Length (mm): 194   Bearing Housing (mm): 315   Max. Permissible Vertical Load (kg): 2000   Shaft Height x Width: 102x102   Max. Permissible Towable Mass (kg): 14000   Approval Status: CUNA</b></p>
	<p><b>Art.Nr. 00.663.63.0-A02   Towing Eyes   Roundshaft</b>  Ring Towing Eye Cuna F3 DØ76mm turnable  </p> <p>Only useable in Italy</p> <p><b>Alternative color</b> </p> <p>00.663.63.0-A02 (Black )</p> <p><b>Technical Values*</b></p> <p><b>Shaft Diameter Ø (mm): 80   Thread: M45   Working Length (mm): 194   Bearing Housing (mm): 315   Max. Permissible Vertical Load (kg): 2500   Max. Permissible Towable Mass (kg): 20000   Approval Status: CUNA</b></p>

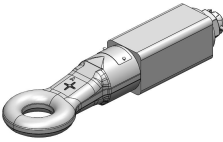
## Towing Eyes | Roundshaft

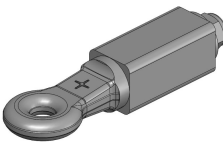
	<p><b>Art.Nr. 00.663.630.0-A02   Towing Eyes   Roundshaft</b>  Ring Towing Eye Cuna F3 DØ76mm turnable  </p> <p>Only useable in Italy!</p> <p><b>Alternative color</b> </p> <p>00.663.630.0-A02 (Black )</p> <p><b>Technical Values*</b></p> <p><b>Shaft Diameter Ø (mm):</b> 80   <b>Thread:</b> M45   <b>Working Length (mm):</b> 194   <b>Bearing Housing (mm):</b> 315   <b>Max. Permissible Vertical Load (kg):</b> 2500   <b>Shaft Height x Width:</b> 102x102   <b>Max. Permissible Towable Mass (kg):</b> 20000   <b>Approval Status:</b> CUNA</p>
	<p><b>Art.Nr. 00.663.710.0-A02   Towing Eyes   Roundshaft</b>  Ring Towing Eye GOST DØ90mm  </p> <p><b>Alternative color</b> </p> <p>00.663.710.0-A02 (Black )</p> <p><b>Technical Values*</b></p> <p><b>Shaft Diameter Ø (mm):</b> 80   <b>Thread:</b> M45   <b>Working Length (mm):</b> 169   <b>Bearing Housing (mm):</b> 315   <b>Max. Permissible D-Value (kN):</b> 102,4   <b>Max. Permissible Vertical Load (kg):</b> 3000   <b>Approval Status:</b></p>
	<p><b>Art.Nr. 00.663.76.0-A02   Towing Eyes   Roundshaft</b>  Ball Joint Towing Eye Cuna F3 Ø51mm turnable  </p> <p>Only useable in Italy</p> <p><b>Alternative color</b> </p> <p>00.663.76.0-A02 (Black )</p> <p><b>Technical Values*</b></p> <p><b>Shaft Diameter Ø (mm):</b> 80   <b>Thread:</b> M45   <b>Working Length (mm):</b> 154   <b>Bearing Housing (mm):</b> 315   <b>Max. Permissible D-Value (kN):</b> 120,2   <b>Max. Permissible Vertical Load (kg):</b> 3000   <b>Shaft Height x Width:</b> 102x102   <b>Approval Status:</b> VO (EU) 2015/208</p>
	<p><b>Art.Nr. 00.663.760.0-A02   Towing Eyes   Roundshaft</b>  Ball Joint Towing Eye Cuna F3 Ø51mm turnable  </p> <p>Only useable in Italy</p> <p><b>Alternative color</b> </p> <p>00.663.760.0-A02 (Black )</p> <p><b>Technical Values*</b></p> <p><b>Shaft Diameter Ø (mm):</b> 80   <b>Thread:</b> M45   <b>Working Length (mm):</b> 154   <b>Bearing Housing (mm):</b> 315   <b>Max. Permissible D-Value (kN):</b> 120,2   <b>Max. Permissible Vertical Load (kg):</b> 3000   <b>Approval Status:</b> VO (EU) 2015/208</p>
	<p><b>Art.Nr. 00.666.20.6-A01   Towing Eyes   Roundshaft</b>  Standard Towing Eye DØ40mm (42mm thick)  </p> <p><b>Alternative color</b> </p> <p>00.666.20.6-A01 (Black-Primer )</p> <p><b>Technical Values*</b></p> <p><b>Shaft Diameter Ø (mm):</b> 60   <b>Thread:</b> M30   <b>Working Length (mm):</b> 150   <b>Bearing Housing (mm):</b> 160   <b>Max. Permissible Vertical Load (kg):</b> 1000   <b>Shaft Height x Width:</b> 75x75   <b>Max. Permissible Dc-Value (kN):</b> 62,8   <b>Max. Permissible V-Value (kN):</b> 25   <b>Approval Status:</b> ECE-55R</p>

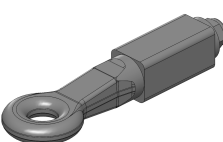
## Towing Eyes | Roundshaft

	<p><b>Art.Nr. 00.666.22.6-A01   Towing Eyes   Roundshaft</b>  Standard Towing Eye DØ40mm (42mm thick)  </p> <p><b>Alternative color</b> </p> <p>00.666.22.6-A01 (Black-Primer)</p> <p><b>Technical Values*</b></p> <p><b>Shaft Diameter Ø (mm): 60   Thread: M30   Working Length (mm): 150   Bearing Housing (mm): 200   Max. Permissible Vertical Load (kg): 1000   Shaft Height x Width: 90x90   Max. Permissible Dc-Value (kN): 62,8   Max. Permissible V-Value (kN): 25   Approval Status: ECE-55R</b></p>
	<p><b>Art.Nr. 00.666.42.0-A01   Towing Eyes   Roundshaft</b>  Ring Towing Eye DØ50mm turnable (Pickup Hitchring)  </p> <p><b>Alternative color</b> </p> <p>00.666.42.0-A01 (Black-Primer)</p> <p><b>Technical Values*</b></p> <p><b>Shaft Diameter Ø (mm): 60   Thread: M30x2   Working Length (mm): 192   Bearing Housing (mm): 160   Max. Permissible D-Value (kN): 62,8   Max. Permissible Vertical Load (kg): 2000   Shaft Height x Width: 75x75   Approval Status: VO (EU) 2015/208</b></p>
	<p><b>Art.Nr. 00.666.61.1-A01   Towing Eyes   Roundshaft</b>  Ring Towing Eye Cuna E3 DØ35mm turnable  </p> <p>Only useable in Italy</p> <p><b>Alternative color</b> </p> <p>00.666.61.1-A01 (Black-Primer)</p> <p><b>Technical Values*</b></p> <p><b>Shaft Diameter Ø (mm): 60   Thread: M30   Working Length (mm): 125   Bearing Housing (mm): 160   Max. Permissible D-Value (kN): 62,8   Max. Permissible Vertical Load (kg): 2000   Shaft Height x Width: 75x75   Approval Status:</b></p>
	<p><b>Art.Nr. 00.666.62.1-A01   Towing Eyes   Roundshaft</b>  Ring Towing Eye Cuna F2 DØ50mm turnable  </p> <p>Only useable in Italy</p> <p><b>Alternative color</b> </p> <p>00.666.62.1-A01 (Black-Primer)</p> <p><b>Technical Values*</b></p> <p><b>Shaft Diameter Ø (mm): 60   Thread: M30   Working Length (mm): 155   Bearing Housing (mm): 160   Max. Permissible D-Value (kN): 62,8   Max. Permissible Vertical Load (kg): 2000   Shaft Height x Width: 75x75   Approval Status:</b></p>