

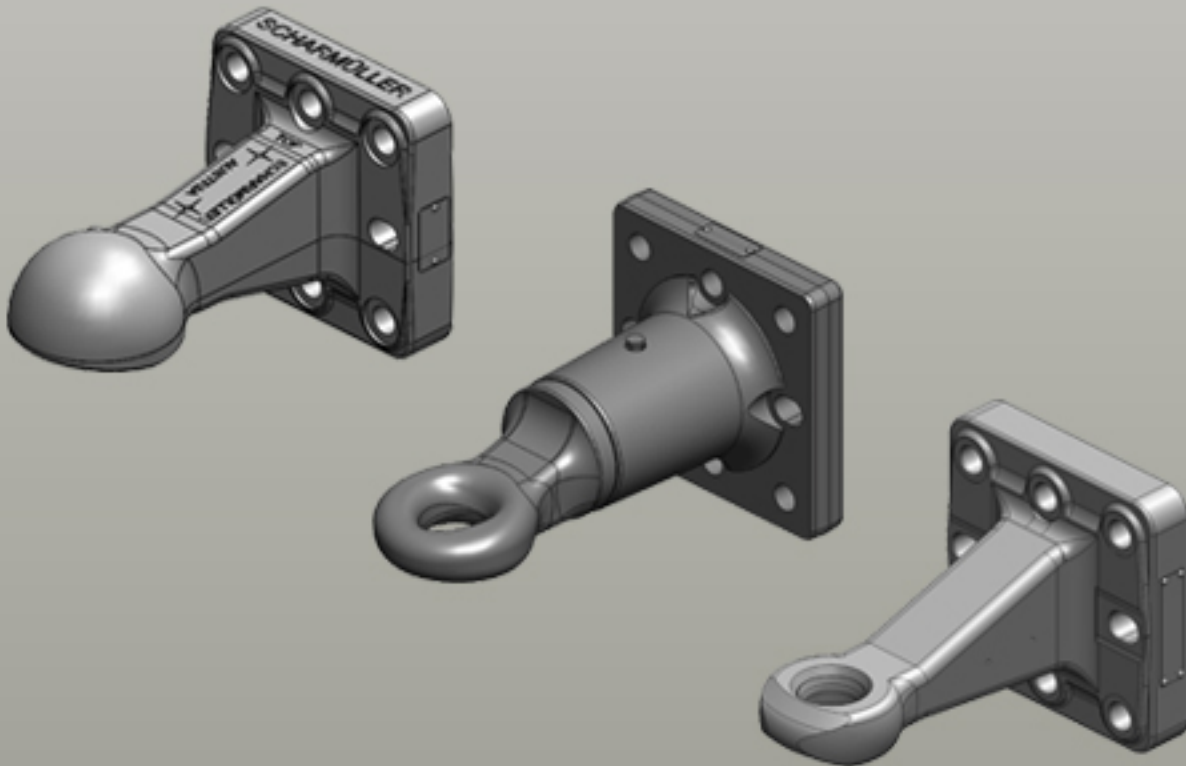

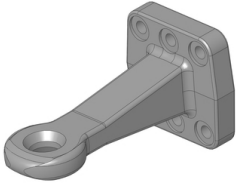







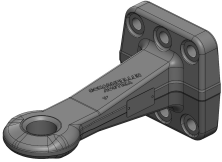

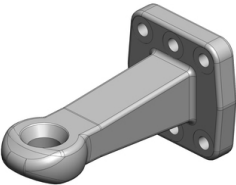

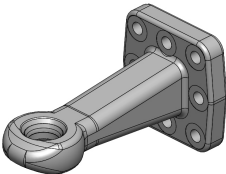

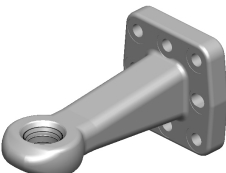



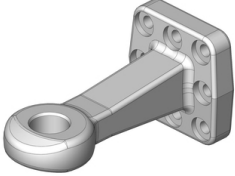

Towing Eyes | Flange

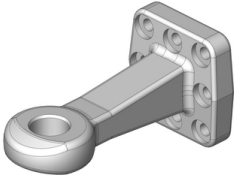

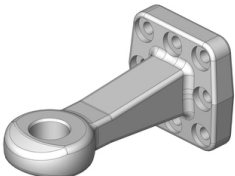
Towing Eyes | Flange

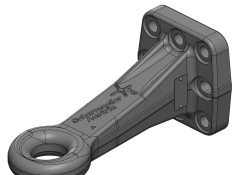
	<p>Art.Nr. 00.652.10.0-A90 Towing Eyes Flange Standard Towing Eye DØ40mm (30mm thick) </p> <p>Alternative color </p> <p>00.652.10.0-A90 (EPD Coating Black)</p> <p>Technical Values*</p> <p>Flange Hole Pattern (mm): 110x100 Thread: M16 Hole Pattern Holes: 6 Flange Alignment: Vertical Working Length (mm): 252 Max. Permissible D-Value (kN): 125 Max. Permissible Vertical Load (kg): 1000 Max. Permissible Dc-Value (kN): 100 Max. Permissible V-Value (kN): 40 Approval Status: ECE-55R</p>
	<p>Art.Nr. 00.652.11.0-A90 Towing Eyes Flange Standard Towing Eye DØ40mm (30mm thick) </p> <p>with Bushing</p> <p>Alternative color </p> <p>00.652.11.0-A90 (EPD Coating Black)</p> <p>Technical Values*</p> <p>Flange Hole Pattern (mm): 110x100 Thread: M16 Hole Pattern Holes: 6 Flange Alignment: Vertical Working Length (mm): 250 Max. Permissible D-Value (kN): 89,3 Max. Permissible Vertical Load (kg): 2000 Approval Status: VO (EU) 2015/208</p>
	<p>Art.Nr. 00.652.24.0-A90 Towing Eyes Flange Standard Towing Eye DØ40mm (42mm thick) </p> <p>with Bushing</p> <p>Alternative color </p> <p>00.652.24.0-A90 (EPD Coating Black)</p> <p>Technical Values*</p> <p>Flange Hole Pattern (mm): 110x100 Thread: M16 Hole Pattern Holes: 6 Flange Alignment: Vertical Working Length (mm): 240 Max. Permissible D-Value (kN): 89,3 Max. Permissible Vertical Load (kg): 2500 Approval Status: VO (EU) 2015/208</p>
	<p>Art.Nr. 00.652.25.0-A90 Towing Eyes Flange Standard Towing Eye DØ40mm (42mm thick) </p> <p>with Bushing</p> <p>Alternative color </p> <p>00.652.25.0-A90 (EPD Coating Black)</p> <p>Technical Values*</p> <p>Flange Hole Pattern (mm): 110x100 Thread: M16 Hole Pattern Holes: 8 Flange Alignment: Vertical Working Length (mm): 240 Max. Permissible D-Value (kN): 89,3 Max. Permissible Vertical Load (kg): 2500 Approval Status: VO (EU) 2015/208</p>
	<p>Art.Nr. 00.652.26.0-A90 Towing Eyes Flange Standard Towing Eye DØ40mm (42mm thick) </p> <p>with Bushing and slotted Holes</p> <p>Alternative color </p> <p>00.652.26.0-A90 (EPD Coating Black)</p> <p>Technical Values*</p> <p>Flange Hole Pattern (mm): 110x100 Thread: M16 Hole Pattern Holes: 8 Flange Alignment: Vertical Working Length (mm): 240 Max. Permissible D-Value (kN): 89,3 Max. Permissible Vertical Load (kg): 2500 Approval Status: VO (EU) 2015/208</p>

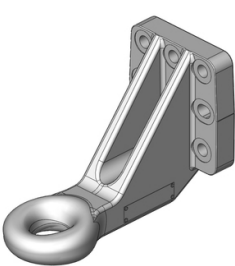







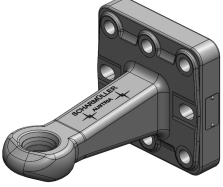

Towing Eyes | Flange

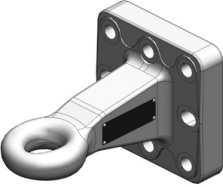
	<p>Art.Nr. 00.652.30.0-A90 Towing Eyes Flange Standard Towing Eye DØ50mm (truck/lorry towing eye) </p> <p>with Bushing</p> <p>Alternative color </p> <p>00.652.30.0-A90 (EPD Coating Black)</p> <p>Technical Values*</p> <p>Flange Hole Pattern (mm): 110x100 Thread: M16 Hole Pattern Holes: 8 Flange Alignment: Vertical Working Length (mm): 250 Max. Permissible Vertical Load (kg): 1000 Max. Permissible Dc-Value (kN): 120 Max. Permissible V-Value (kN): 50 Approval Status: ECE-55R</p>
	<p>Art.Nr. 00.652.31.0-A90 Towing Eyes Flange Standard Towing Eye DØ50mm (truck/lorry towing eye) </p> <p>with Bushing with Type Plate for Homologation after Land and Forestry ABG and Street Homologation after 94/20/EC + ECE-55R</p> <p>Alternative color </p> <p>00.652.31.0-A90 (EPD Coating Black)</p> <p>Technical Values*</p> <p>Flange Hole Pattern (mm): 110x100 Thread: M16 Hole Pattern Holes: 8 Flange Alignment: Vertical Working Length (mm): 250 Max. Permissible D-Value (kN): 190 Max. Permissible Vertical Load (kg): 2500 Max. Permissible Dc-Value (kN): 135 Max. Permissible V-Value (kN): 75 Approval Status: 94/20/EC</p>
	<p>Art.Nr. 00.652.32.0-A90 Towing Eyes Flange Standard Towing Eye DØ50mm (truck/lorry towing eye) </p> <p>with Bushing</p> <p>Alternative color </p> <p>00.652.32.0-A90 (EPD Coating Black)</p> <p>Technical Values*</p> <p>Flange Hole Pattern (mm): 110x100 Thread: M16 Hole Pattern Holes: 8 Flange Alignment: Vertical Working Length (mm): 250 Max. Permissible D-Value (kN): 89,3 Max. Permissible Vertical Load (kg): 3000 Approval Status: VO (EU) 2015/208</p>
	<p>Art.Nr. 00.652.42.0-A90 Towing Eyes Flange Ring Towing Eye DØ50mm rigid (Pickup Hitchring) </p> <p>Alternative color </p> <p>00.652.42.0-A90 (EPD Coating Black)</p> <p>Technical Values*</p> <p>Flange Hole Pattern (mm): 110x100 Thread: M16 Hole Pattern Holes: 8 Flange Alignment: Vertical Working Length (mm): 277 Max. Permissible D-Value (kN): 89,3 Max. Permissible Vertical Load (kg): 3000 Approval Status: VO (EU) 2015/208</p>
	<p>Art.Nr. 00.652.45.0-A02 Towing Eyes Flange Ring Towing Eye DØ50mm rigid (Pickup Hitchring) </p> <p>Alternative color </p> <p>00.652.45.0-A02 (Black)</p> <p>Technical Values*</p> <p>Flange Hole Pattern (mm): 110x100 Thread: M16 Hole Pattern Holes: 8 Flange Alignment: Vertical Working Length (mm): 240 Max. Permissible D-Value (kN): 91,7 Max. Permissible Vertical Load (kg): 2500 Approval Status: ABG General Type Approval</p>

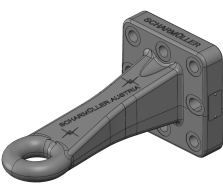

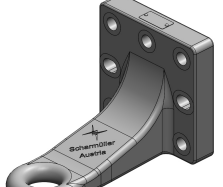



Towing Eyes | Flange

	<p>Art.Nr. 00.652.460.0-A02 Towing Eyes Flange Ring Towing Eye DØ50mm rigid (Pickup Hitchring) </p> <p>Alternative color </p> <p>00.652.460.0-A02 (Black)</p> <p>Technical Values*</p> <p>Flange Hole Pattern (mm): 110x100 Thread: M20x1,5 Hole Pattern Holes: 8 Flange Alignment: Vertical Working Length (mm): 335 Max. Permissible D-Value (kN): 89,3 Max. Permissible Vertical Load (kg): 2500 Approval Status: VO (EU) 2015/208</p>
	<p>Art.Nr. 00.652.50.1-A02 Towing Eyes Flange Standard Towing Eye DØ40mm (42mm thick) </p> <p>Alternative color </p> <p>00.652.50.1-A02 (Black)</p> <p>Technical Values*</p> <p>Flange Hole Pattern (mm): 110x100 Thread: M16 Hole Pattern Holes: 8 Flange Alignment: Vertical Working Length (mm): 256 Max. Permissible D-Value (kN): 83,9 Max. Permissible Vertical Load (kg): 2500 Approval Status: ABG General Type Approval</p>
	<p>Art.Nr. 00.652.520.0-A02 Towing Eyes Flange Standard Towing Eye DØ40mm (42mm thick) </p> <p>with Bushing</p> <p>Alternative color </p> <p>00.652.520.0-A02 (Black)</p> <p>Technical Values*</p> <p>Flange Hole Pattern (mm): 110x100 Thread: M20x1,5 Hole Pattern Holes: 8 Flange Alignment: Vertical Working Length (mm): 334 Max. Permissible D-Value (kN): 89,3 Max. Permissible Vertical Load (kg): 2500 Approval Status: VO (EU) 2015/208</p>
	<p>Art.Nr. 00.653.40.0-A02 Towing Eyes Flange Ring Towing Eye DØ50mm rigid (Pickup Hitchring) </p> <p>Alternative color </p> <p>00.653.40.0-A02 (Black)</p> <p>Technical Values*</p> <p>Flange Hole Pattern (mm): 130x130 Thread: M20 Hole Pattern Holes: 8 Flange Alignment: Vertical Working Length (mm): 240 Max. Permissible D-Value (kN): 90,9 Max. Permissible Vertical Load (kg): 3000 Approval Status: ABG General Type Approval</p>
	<p>Art.Nr. 00.654.11.0-A02 Towing Eyes Flange Ring Towing Eye DØ62mm rigid (Challenger) </p> <p>Alternative color </p> <p>00.654.11.0-A02 (Black)</p> <p>Technical Values*</p> <p>Flange Hole Pattern (mm): 145x145 Thread: M20 Hole Pattern Holes: 8 Flange Alignment: Vertical Working Length (mm): 250 Max. Permissible D-Value (kN): 83,1 Max. Permissible Vertical Load (kg): 3000 Approval Status: ABG General Type Approval</p>

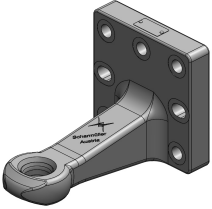
Towing Eyes | Flange

	<p>Art.Nr. 00.654.24.0-A02 Towing Eyes Flange Standard Towing Eye DØ40mm (42mm thick) </p> <p>with Bushing</p> <p>Alternative color </p> <p>00.654.24.0-A02 (Black)</p> <p>Technical Values*</p> <p>Flange Hole Pattern (mm): 145x145 Thread: M20 Hole Pattern Holes: 8 Flange Alignment: Vertical Working Length (mm): 250 Max. Permissible D-Value (kN): 102,4 Max. Permissible Vertical Load (kg): 3000 Approval Status: VO (EU) 2015/208</p>
	<p>Art.Nr. 00.654.41.0-A02 Towing Eyes Flange Ring Towing Eye DØ50mm rigid (Pickup Hitchring) </p> <p>Alternative color </p> <p>00.654.41.0-A02 (Black)</p> <p>Technical Values*</p> <p>Flange Hole Pattern (mm): 145x145 Thread: M20 Hole Pattern Holes: 8 Flange Alignment: Vertical Working Length (mm): 252 Max. Permissible D-Value (kN): 102,4 Max. Permissible Vertical Load (kg): 3000 Approval Status: ABG General Type Approval</p>
	<p>Art.Nr. 00.654.41.1-A02 Towing Eyes Flange Ring Towing Eye DØ50mm rigid (Pickup Hitchring) </p> <p>with Type Plate for Homologation after Land and Forestry VO_208_2015</p> <p>Alternative color </p> <p>00.654.41.1-A02 (Black)</p> <p>Technical Values*</p> <p>Flange Hole Pattern (mm): 145x145 Thread: M20 Hole Pattern Holes: 8 Flange Alignment: Vertical Working Length (mm): 345 Max. Permissible D-Value (kN): 102,4 Max. Permissible Vertical Load (kg): 3000 Approval Status: VO (EU) 2015/208</p>
	<p>Art.Nr. 00.654.45.0-A02 Towing Eyes Flange Ring Towing Eye DØ50mm rigid (Pickup Hitchring) </p> <p>Alternative color </p> <p>00.654.45.0-A02 (Black)</p> <p>Technical Values*</p> <p>Flange Hole Pattern (mm): 145x145 Thread: M20 Hole Pattern Holes: 7 Flange Alignment: Vertical Working Length (mm): 255 Max. Permissible D-Value (kN): 102,4 Max. Permissible Vertical Load (kg): 2500 Approval Status:</p>
	<p>Art.Nr. 00.654.46.0-A02 Towing Eyes Flange Ring Towing Eye DØ50mm rigid (Pickup Hitchring) </p> <p>Alternative color </p> <p>00.654.46.0-A02 (Black)</p> <p>Technical Values*</p> <p>Flange Hole Pattern (mm): 145x145 Thread: M20 Hole Pattern Holes: 7 Flange Alignment: Vertical Working Length (mm): 340 Max. Permissible D-Value (kN): 102,4 Max. Permissible Vertical Load (kg): 2000 Approval Status: VO (EU) 2015/208</p>

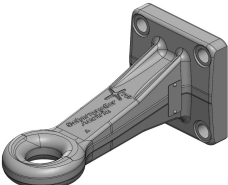
Towing Eyes | Flange

	<p>Art.Nr. 00.654.50.0-A02 Towing Eyes Flange Standard Towing Eye DØ40mm (42mm thick) </p> <p>with Bushing</p> <p>Alternative color </p> <p>00.654.50.0-A02 (Black)</p> <p>Technical Values*</p> <p>Flange Hole Pattern (mm): 145x145 Thread: M20 Hole Pattern Holes: 7 Flange Alignment: Vertical Working Length (mm): 254 Max. Permissible D-Value (kN): 102,4 Max. Permissible Vertical Load (kg): 2500 Approval Status: VO (EU) 2015/208</p>
	<p>Art.Nr. 00.655.21.0-A02 Towing Eyes Flange Standard Towing Eye DØ40mm (42mm thick) </p> <p>with Bushing</p> <p>Alternative color </p> <p>00.655.21.0-A02 (Black)</p> <p>Technical Values*</p> <p>Flange Hole Pattern (mm): 130x115 Thread: M20 Hole Pattern Holes: 6 Flange Alignment: Horizontal Working Length (mm): 314 Max. Permissible D-Value (kN): 102,4 Max. Permissible Vertical Load (kg): 2500 Approval Status: VO (EU) 2015/208</p>
	<p>Art.Nr. 00.655.51.0-A02 Towing Eyes Flange Ring Towing Eye DØ50mm rigid (Pickup Hitchring) </p> <p>Alternative color </p> <p>00.655.51.0-A02 (Black)</p> <p>Technical Values*</p> <p>Flange Hole Pattern (mm): 130x115 Thread: M20 Hole Pattern Holes: 6 Flange Alignment: Horizontal Working Length (mm): 314 Max. Permissible Vertical Load (kg): 3000 Max. Permissible Towable Mass (kg): 30000 Approval Status: ABG General Type Approval</p>
	<p>Art.Nr. 00.664.21.0-A02 Towing Eyes Flange Standard Towing Eye DØ40mm (42mm thick) </p> <p>with Bushing</p> <p>Alternative color </p> <p>00.664.21.0-A02 (Black)</p> <p>Technical Values*</p> <p>Flange Hole Pattern (mm): 120x120 Thread: M20 Hole Pattern Holes: 4 Flange Alignment: Vertical Working Length (mm): 260 Max. Permissible D-Value (kN): 89,3 Max. Permissible Vertical Load (kg): 3000 Approval Status: VO (EU) 2015/208</p> <p>Geeignete Anhänger</p> <p>Claas: Quadrant: 3200, 3400;</p>
	<p>Art.Nr. 00.664.42.1-A90 Towing Eyes Flange Ring Towing Eye DØ50mm rigid (Pickup Hitchring) </p> <p>with Type Plate for Homologation after Land and Forestry VO_208_2015</p> <p>Alternative color </p> <p>00.664.42.1-A90 (EPD Coating Black)</p> <p>Technical Values*</p> <p>Flange Hole Pattern (mm): 120x120 Thread: M20 Hole Pattern Holes: 4 Flange Alignment: Vertical Working Length (mm): 277 Max. Permissible D-Value (kN): 89,3 Max. Permissible Vertical Load (kg): 3000 Approval Status: VO (EU) 2015/208</p>

Towing Eyes | Flange

	<p>Art.Nr. 00.664.43.0-A02 Towing Eyes Flange Ring Towing Eye DØ50mm rigid (Pickup Hitchring) </p> <p>Alternative color </p> <p>00.664.43.0-A02 (Black)</p> <p>Technical Values*</p> <p>Flange Hole Pattern (mm): 120x120 Thread: M20 Hole Pattern Holes: 4 Flange Alignment: Vertical Working Length (mm): 260 Max. Permissible D-Value (kN): 84,2 Max. Permissible Vertical Load (kg): 2500 Approval Status: ABG General Type Approval</p> <p>Geeignete Anhänger</p> <p>Claas: Quadrant: 3200, 3400;</p>
	<p>Art.Nr. 00.665.11.0-A02 Towing Eyes Flange Ring Towing Eye DØ62mm rigid (Challenger) </p> <p>Alternative color </p> <p>00.665.11.0-A02 (Black)</p> <p>Technical Values*</p> <p>Flange Hole Pattern (mm): 160x160 Thread: M20 Hole Pattern Holes: 12 Flange Alignment: Vertical Working Length (mm): 260 Max. Permissible D-Value (kN): 83,1 Max. Permissible Vertical Load (kg): 3300 Approval Status: ABG General Type Approval</p>
	<p>Art.Nr. 00.665.21.0-A02 Towing Eyes Flange Standard Towing Eye DØ40mm (42mm thick) </p> <p>with Bushing</p> <p>Alternative color </p> <p>00.665.21.0-A02 (Black)</p> <p>Technical Values*</p> <p>Flange Hole Pattern (mm): 160x160 Thread: M20 Hole Pattern Holes: 12 Flange Alignment: Vertical Working Length (mm): 252 Max. Permissible D-Value (kN): 102,4 Max. Permissible Vertical Load (kg): 3000 Approval Status: VO (EU) 2015/208</p>
	<p>Art.Nr. 00.665.25.0-A02 Towing Eyes Flange Ring Towing Eye Cat. 2 DØ37mm </p> <p>Alternative color </p> <p>00.665.25.0-A02 (Black)</p> <p>Technical Values*</p> <p>Flange Hole Pattern (mm): 160x160 Thread: M20 Hole Pattern Holes: 12 Flange Alignment: Vertical Working Length (mm): 250 Max. Permissible D-Value (kN): 120 Max. Permissible Vertical Load (kg): 3000 Approval Status: VO (EU) 2015/208</p>
	<p>Art.Nr. 00.665.26.0-A02 Towing Eyes Flange Ring Towing Eye Cat. 3 DØ46mm </p> <p>Alternative color </p> <p>00.665.26.0-A02 (Black)</p> <p>Technical Values*</p> <p>Flange Hole Pattern (mm): 160x160 Thread: M20 Hole Pattern Holes: 12 Flange Alignment: Vertical Working Length (mm): 250 Max. Permissible D-Value (kN): 120 Max. Permissible Vertical Load (kg): 3000 Approval Status: VO (EU) 2015/208</p>

Towing Eyes | Flange

	<p>Art.Nr. 00.665.27.0-A02 Towing Eyes Flange Ring Towing Eye Cat. 4 DØ58mm </p> <p>Alternative color </p> <p>00.665.27.0-A02 (Black)</p> <p>Technical Values*</p> <p>Flange Hole Pattern (mm): 160x160 Thread: M20 Hole Pattern Holes: 12 Flange Alignment: Vertical Working Length (mm): 250 Max. Permissible D-Value (kN): 120 Max. Permissible Vertical Load (kg): 3000 Approval Status: VO (EU) 2015/208</p>
	<p>Art.Nr. 00.665.28.0-A02 Towing Eyes Flange Ring Towing Eye Cat. 5 DØ79mm </p> <p>Alternative color </p> <p>00.665.28.0-A02 (Black)</p> <p>Technical Values*</p> <p>Flange Hole Pattern (mm): 160x160 Thread: M20 Hole Pattern Holes: 12 Flange Alignment: Vertical Working Length (mm): 250 Max. Permissible D-Value (kN): 120 Max. Permissible Vertical Load (kg): 3000 Approval Status: VO (EU) 2015/208</p>
	<p>Art.Nr. 00.665.42.0-A02 Towing Eyes Flange Ring Towing Eye DØ50mm rigid (Pickup Hitchring) </p> <p>Alternative color </p> <p>00.665.42.0-A02 (Black)</p> <p>Technical Values*</p> <p>Flange Hole Pattern (mm): 160x160 Thread: M20 Hole Pattern Holes: 12 Flange Alignment: Vertical Working Length (mm): 250 Max. Permissible D-Value (kN): 102,4 Max. Permissible Vertical Load (kg): 3000 Approval Status: 94/20/EC</p>
	<p>Art.Nr. 00.665.42.1-A02 Towing Eyes Flange Ring Towing Eye DØ50mm rigid (Pickup Hitchring) </p> <p>with Type Plate for Homologation after Land and Forestry VO_208_2015</p> <p>Alternative color </p> <p>00.665.42.1-A02 (Black)</p> <p>Technical Values*</p> <p>Flange Hole Pattern (mm): 160x160 Thread: M20 Hole Pattern Holes: 12 Flange Alignment: Vertical Working Length (mm): 342 Max. Permissible D-Value (kN): 102,4 Max. Permissible Vertical Load (kg): 3000 Approval Status: VO (EU) 2015/208</p>
	<p>Art.Nr. 00.665.43.1-A02 Towing Eyes Flange Ring Towing Eye DØ50mm rigid (Pickup Hitchring) </p> <p>Alternative color </p> <p>00.665.43.1-A02 (Black)</p> <p>Technical Values*</p> <p>Flange Hole Pattern (mm): 160x160 Thread: M20 Hole Pattern Holes: 12 Flange Alignment: Vertical Working Length (mm): 248 Max. Permissible D-Value (kN): 91,3 Max. Permissible Vertical Load (kg): 4000 Approval Status: ABG General Type Approval</p>

Towing Eyes | Flange

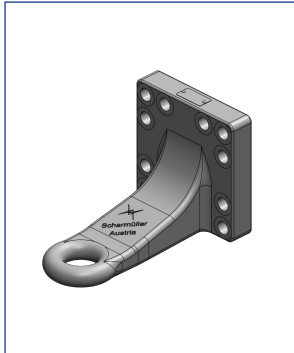

Art.Nr. 00.665.45.0-A02 Towing Eyes Flange Ring Towing Eye DØ50mm rigid (Pickup Hitchring)
Alternative color 
00.665.45.0-A02 (Black)
Technical Values*
Flange Hole Pattern (mm): 160x160 Thread: M20 Hole Pattern Holes: 10 Flange Alignment: Vertical Working Length (mm): 255 Max. Permissible D-Value (kN): 102,4 Max. Permissible Vertical Load (kg): 2500 Approval Status:

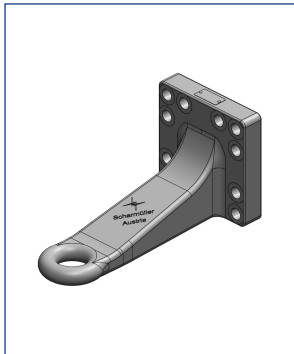

Art.Nr. 00.665.46.0-A02 Towing Eyes Flange Ring Towing Eye DØ50mm rigid (Pickup Hitchring)
Alternative color 
00.665.46.0-A02 (Black)
Technical Values*
Flange Hole Pattern (mm): 160x160 Thread: M20 Hole Pattern Holes: 10 Flange Alignment: Vertical Working Length (mm): 340 Max. Permissible D-Value (kN): 102,4 Max. Permissible Vertical Load (kg): 2000 Approval Status: VO (EU) 2015/208

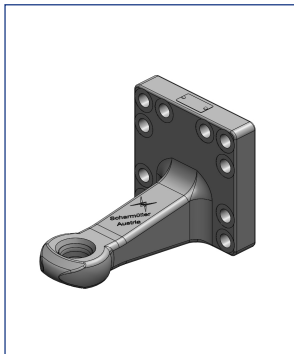

Art.Nr. 00.665.50.0-A02 Towing Eyes Flange Standard Towing Eye DØ40mm (42mm thick) with Bushing
Alternative color 
00.665.50.0-A02 (Black)
Technical Values*
Flange Hole Pattern (mm): 160x160 Thread: M20 Hole Pattern Holes: 10 Flange Alignment: Vertical Working Length (mm): 254 Max. Permissible D-Value (kN): 102,4 Max. Permissible Vertical Load (kg): 2500 Approval Status: VO (EU) 2015/208