

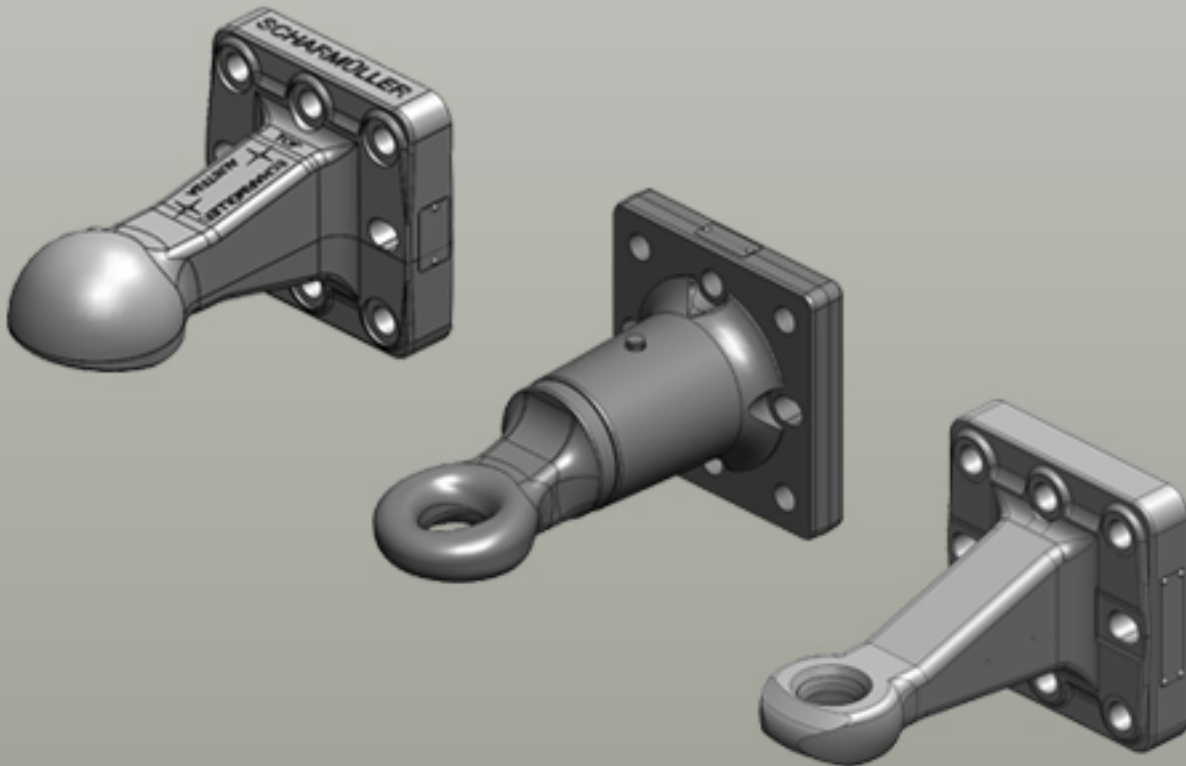









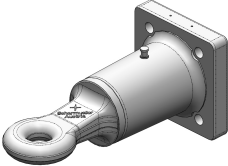

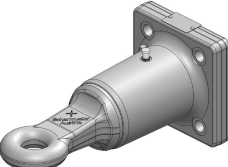
Towing Eyes | Flange

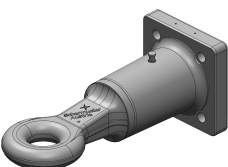

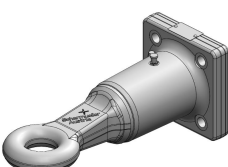
Ball Joint Towing Eye Cuna F3 Ø51mm turnable | Ring Towing Eye Cuna E3 DØ35mm turnable | Ring Towing Eye Cuna F2 DØ50mm turnable | Ring Towing Eye Cuna F3 DØ76mm turnable

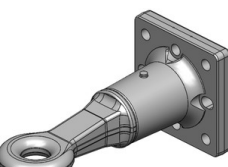





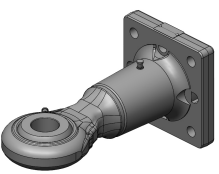



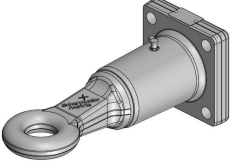

Towing Eyes | Flange

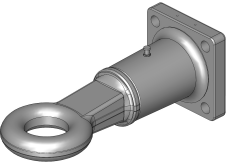
	<p>Art.Nr. 00.652.610.0-A02 Towing Eyes Flange Ring Towing Eye Cuna E3 DØ35mm turnable </p> <p>Only useable in Italy</p> <p>Alternative color </p> <p>00.652.610.0-A02 (Black)</p> <p>Technical Values*</p> <p>Flange Hole Pattern (mm): 110x100 Thread: M16 Hole Pattern Holes: 4 Flange Alignment: Vertical Working Length (mm): 302 Max. Permissible Vertical Load (kg): 1500 Max. Permissible Towable Mass (kg): 6000 Approval Status: CUNA</p>
	<p>Art.Nr. 00.652.612.0-A02 Towing Eyes Flange Ring Towing Eye Cuna E3 DØ35mm turnable </p> <p>Only useable in Italy</p> <p>Alternative color </p> <p>00.652.612.0-A02 (Black)</p> <p>Technical Values*</p> <p>Flange Hole Pattern (mm): 110x100 Thread: M16 Hole Pattern Holes: 4 Flange Alignment: Vertical Working Length (mm): 302 Max. Permissible Vertical Load (kg): 2000 Max. Permissible Towable Mass (kg): 24000 Approval Status: VO (EU) 2015/208</p>
	<p>Art.Nr. 00.652.620.0-A02 Towing Eyes Flange Ring Towing Eye Cuna F2 DØ50mm turnable </p> <p>Only useable in Italy</p> <p>Alternative color </p> <p>00.652.620.0-A02 (Black)</p> <p>Technical Values*</p> <p>Flange Hole Pattern (mm): 110x100 Thread: M16 Hole Pattern Holes: 4 Flange Alignment: Vertical Working Length (mm): 332 Max. Permissible Vertical Load (kg): 2000 Max. Permissible Towable Mass (kg): 20000 Approval Status: CUNA</p>
	<p>Art.Nr. 00.652.622.0-A02 Towing Eyes Flange Ring Towing Eye Cuna F2 DØ50mm turnable </p> <p>Only useable in Italy</p> <p>Alternative color </p> <p>00.652.622.0-A02 (Black)</p> <p>Technical Values*</p> <p>Flange Hole Pattern (mm): 110x100 Thread: M16 Hole Pattern Holes: 4 Flange Alignment: Vertical Working Length (mm): 332 Max. Permissible Vertical Load (kg): 2500 Max. Permissible Towable Mass (kg): 24000 Approval Status: VO (EU) 2015/208</p>
	<p>Art.Nr. 00.654.620.0-A02 Towing Eyes Flange Ring Towing Eye Cuna F2 DØ50mm turnable </p> <p>Only useable in Italy</p> <p>Alternative color </p> <p>00.654.620.0-A02 (Black)</p> <p>Technical Values*</p> <p>Flange Hole Pattern (mm): 145x145 Thread: M20 Hole Pattern Holes: 8 Flange Alignment: Vertical Working Length (mm): 332 Max. Permissible Vertical Load (kg): 2000 Max. Permissible Towable Mass (kg): 14000 Approval Status: CUNA</p>

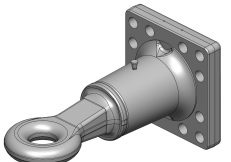
Towing Eyes | Flange

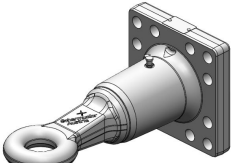
	<p>Art.Nr. 00.654.622.0-A02 Towing Eyes Flange Ring Towing Eye Cuna F2 DØ50mm turnable </p> <p>Only useable in Italy</p> <p>Alternative color </p> <p>00.654.622.0-A02 (Black)</p> <p>Technical Values*</p> <p>Flange Hole Pattern (mm): 145x145 Thread: M20 Hole Pattern Holes: 8 Flange Alignment: Vertical Working Length (mm): 332 Max. Permissible D-Value (kN): 102,4 Max. Permissible Vertical Load (kg): 3000 Approval Status: VO (EU) 2015/208</p>
	<p>Art.Nr. 00.654.630.0-A02 Towing Eyes Flange Ring Towing Eye Cuna F3 DØ76mm turnable </p> <p>Only useable in Italy</p> <p>Alternative color </p> <p>00.654.630.0-A02 (Black)</p> <p>Technical Values*</p> <p>Flange Hole Pattern (mm): 145x145 Thread: M20 Hole Pattern Holes: 8 Flange Alignment: Vertical Working Length (mm): 351 Max. Permissible Vertical Load (kg): 2500 Max. Permissible Towable Mass (kg): 20000 Approval Status: CUNA</p>
	<p>Art.Nr. 00.654.66.1-A02 Towing Eyes Flange Ball Joint Towing Eye Cuna F3 Ø51mm turnable </p> <p>Only useable in Italy</p> <p>Alternative color </p> <p>00.654.66.1-A02 (Black)</p> <p>Technical Values*</p> <p>Flange Hole Pattern (mm): 145x145 Thread: M20 Hole Pattern Holes: 8 Flange Alignment: Vertical Working Length (mm): 332 Max. Permissible D-Value (kN): 93 Max. Permissible Vertical Load (kg): 2500 Approval Status: VO (EU) 2015/208</p>
	<p>Art.Nr. 00.664.610.1-A02 Towing Eyes Flange Ring Towing Eye Cuna E3 DØ35mm turnable </p> <p>Only useable in Italy</p> <p>Alternative color </p> <p>00.664.610.1-A02 (Black)</p> <p>Technical Values*</p> <p>Flange Hole Pattern (mm): 120x120 Thread: M20 Hole Pattern Holes: 4 Flange Alignment: Vertical Working Length (mm): 301 Max. Permissible D-Value (kN): 44,2 Max. Permissible Vertical Load (kg): 1500 Approval Status: VO (EU) 2015/208</p>
	<p>Art.Nr. 00.664.621.0-A02 Towing Eyes Flange Ring Towing Eye Cuna F2 DØ50mm turnable </p> <p>Only useable in Italy</p> <p>Alternative color </p> <p>00.664.621.0-A02 (Black)</p> <p>Technical Values*</p> <p>Flange Hole Pattern (mm): 120x120 Thread: M20 Hole Pattern Holes: 4 Flange Alignment: Vertical Working Length (mm): 332 Max. Permissible Vertical Load (kg): 2000 Max. Permissible Towable Mass (kg): 14000 Approval Status: CUNA</p>

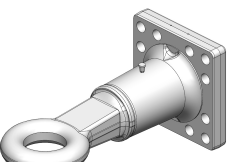
Towing Eyes | Flange

	<p>Art.Nr. 00.664.622.0-A02 Towing Eyes Flange Ring Towing Eye Cuna F2 DØ50mm turnable </p> <p>Only useable in Italy</p> <p>Alternative color </p> <p>00.664.622.0-A02 (Black)</p> <p>Technical Values*</p> <p>Flange Hole Pattern (mm): 120x120 Thread: M20 Hole Pattern Holes: 4 Flange Alignment: Vertical Working Length (mm): 332 Max. Permissible D-Value (kN): 89,3 Max. Permissible Vertical Load (kg): 3000 Approval Status: VO (EU) 2015/208</p>
	<p>Art.Nr. 00.664.631.0-A02 Towing Eyes Flange Ring Towing Eye Cuna F3 DØ76mm turnable </p> <p>Only useable in Italy</p> <p>Alternative color </p> <p>00.664.631.0-A02 (Black)</p> <p>Technical Values*</p> <p>Flange Hole Pattern (mm): 120x120 Thread: M20 Hole Pattern Holes: 4 Flange Alignment: Vertical Working Length (mm): 351 Max. Permissible Vertical Load (kg): 2500 Max. Permissible Towable Mass (kg): 20000 Approval Status: CUNA</p>
	<p>Art.Nr. 00.665.620.0-A02 Towing Eyes Flange Ring Towing Eye Cuna F2 DØ50mm turnable </p> <p>Only useable in Italy</p> <p>Alternative color </p> <p>00.665.620.0-A02 (Black)</p> <p>Technical Values*</p> <p>Flange Hole Pattern (mm): 160x160 Thread: M20 Hole Pattern Holes: 12 Flange Alignment: Vertical Working Length (mm): 332 Max. Permissible Vertical Load (kg): 2000 Max. Permissible Towable Mass (kg): 14000 Approval Status: CUNA</p>
	<p>Art.Nr. 00.665.622.0-A02 Towing Eyes Flange Ring Towing Eye Cuna F2 DØ50mm turnable </p> <p>Only useable in Italy</p> <p>Alternative color </p> <p>00.665.622.0-A02 (Black)</p> <p>Technical Values*</p> <p>Flange Hole Pattern (mm): 160x160 Thread: M20 Hole Pattern Holes: 12 Flange Alignment: Vertical Working Length (mm): 332 Max. Permissible D-Value (kN): 102,4 Max. Permissible Vertical Load (kg): 3000 Approval Status: VO (EU) 2015/208</p>
	<p>Art.Nr. 00.665.630.0-A02 Towing Eyes Flange Ring Towing Eye Cuna F3 DØ76mm turnable </p> <p>Only useable in Italy</p> <p>Alternative color </p> <p>00.665.630.0-A02 (Black)</p> <p>Technical Values*</p> <p>Flange Hole Pattern (mm): 160x160 Thread: M20 Hole Pattern Holes: 12 Flange Alignment: Vertical Working Length (mm): 351 Max. Permissible Vertical Load (kg): 2500 Max. Permissible Towable Mass (kg): 20000 Approval Status: CUNA</p>

Towing Eyes | Flange

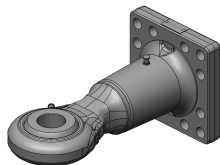

Art.Nr. 00.665.66.1-A02 | Towing Eyes | Flange

Ball Joint Towing Eye Cuna F3 Ø51mm turnable |

Only useable in Italy

Alternative color 

00.665.66.1-A02 (Black)

Technical Values*

Flange Hole Pattern (mm): 160x160 | **Thread:** M20 | **Hole Pattern Holes:** 12 | **Flange Alignment:** Vertical |
Working Length (mm): 332 | **Max. Permissible D-Value (kN):** 93 | **Max. Permissible Vertical Load (kg):** 2500 |
Approval Status: VO (EU) 2015/208